

Modern

Outdoor Patio Side Table

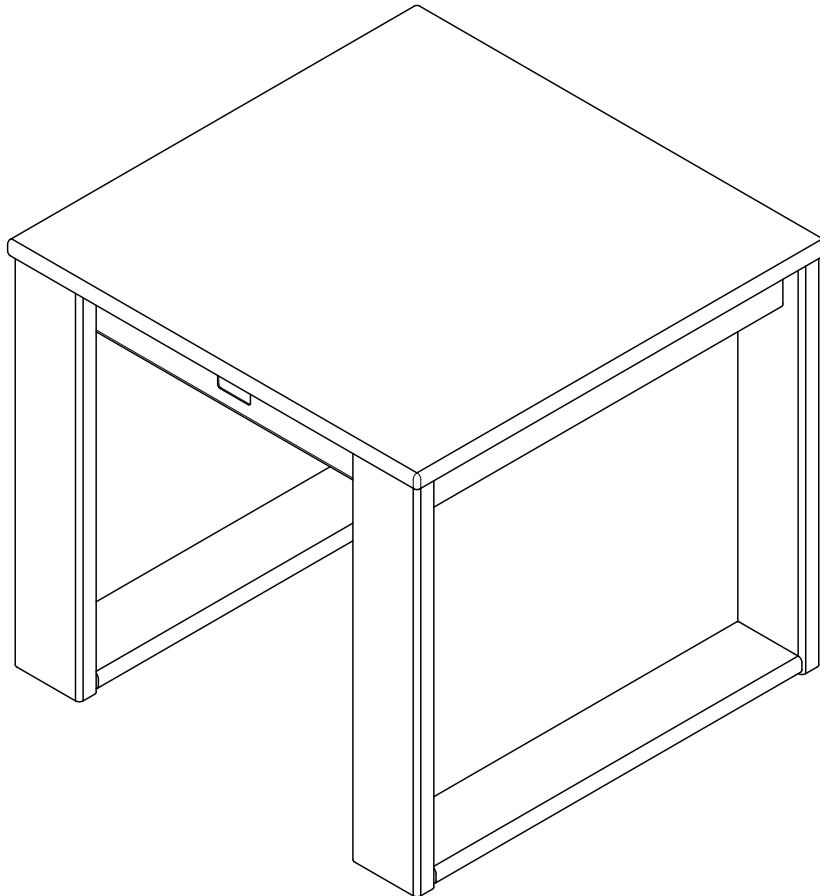

Assembly Instructions

v02 US



Important Note

Please Read Carefully All Sections Before You Start

For the most up to date information, please visit our website @ www.newtechwood.com

1. Parts

Before assembling, please check the packing parts carefully according to the sections on [page 2](#) and [page 3](#), "[Tools](#)", "[Screw](#)" and "[Components](#)" of this Assembly Instruction sheet. If parts are missing, please contact the retailer from which you acquired this Side Table to get the missing parts.

2. Safety

2.1 It is recommended to wear appropriate safety equipment to avoid any risk of injuries but it is not limited to the following safety equipment when assembling the Side Table: gloves, safety goggles, long sleeves, and pants.

2.2 The Side Table is not designed for use as a standing platform or a ladder. **DO NOT** stand on the Side Table as there is a risk of falling and injury.

3. Tools

Always use the proper tools for assembly.

4. Assembling Procedure

4.1 Please follow the steps of the Assembly Instructions sheet in order.

4.2 **DO NOT** tighten all the screws until all the parts are in place and assembling in alignment. Otherwise, it should cause the assembly to be misaligned. It is recommended to turn back the screws half turn when the head of screws touches the parts before tightening all the screws in order.

Warranty: Please visit our website for full warranty @www.newtechwood.com

Tools

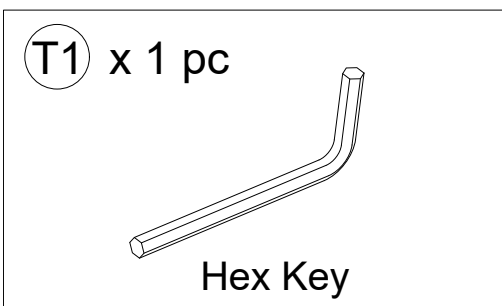

Screw

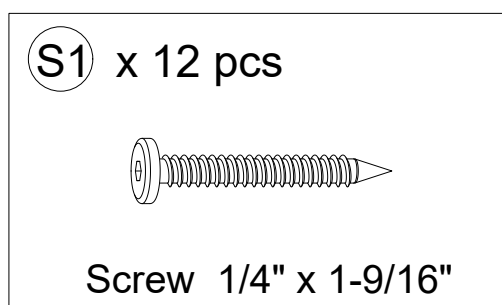

Components

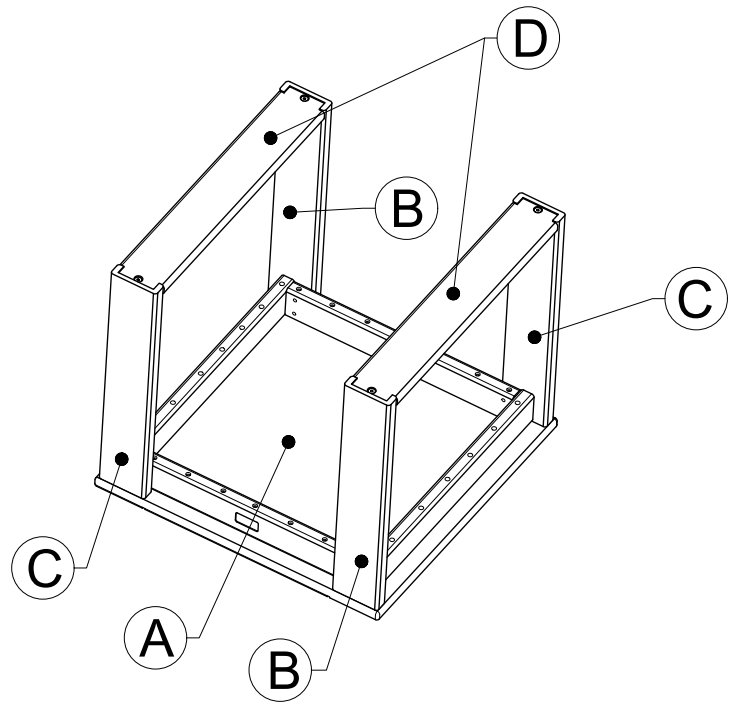
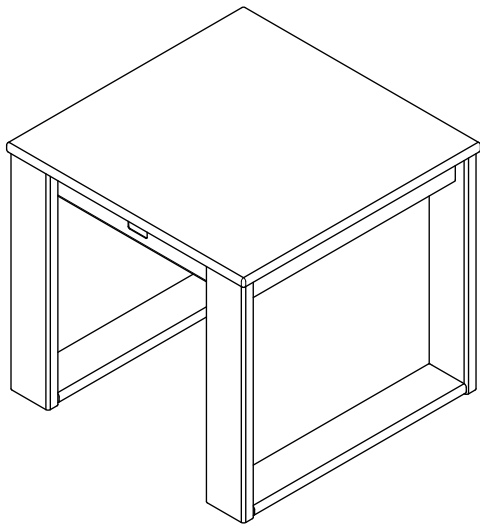

A x 1 pc

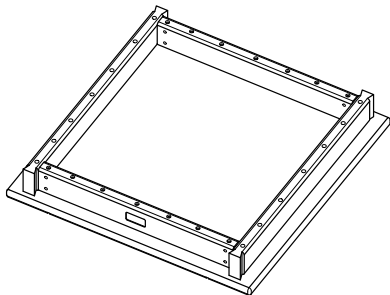

B x 2 pcs



C x 2 pcs



D x 2 pcs

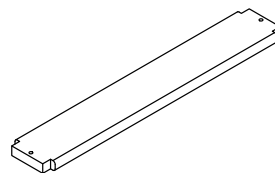

Assembling Procedure

Step 1

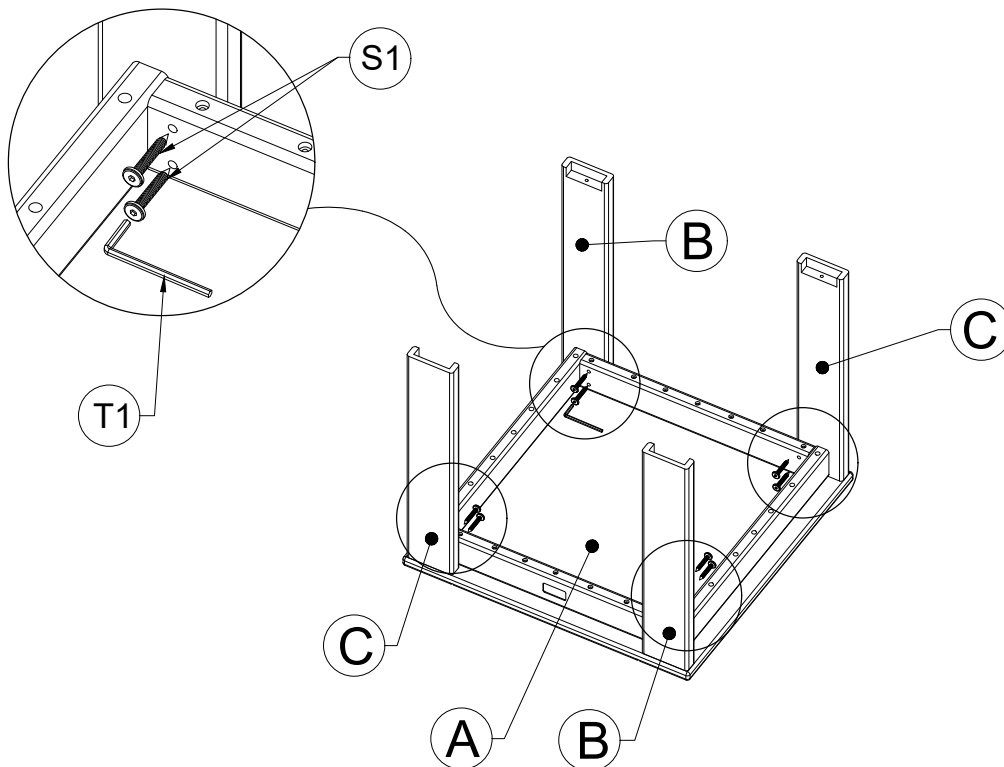

Step 2

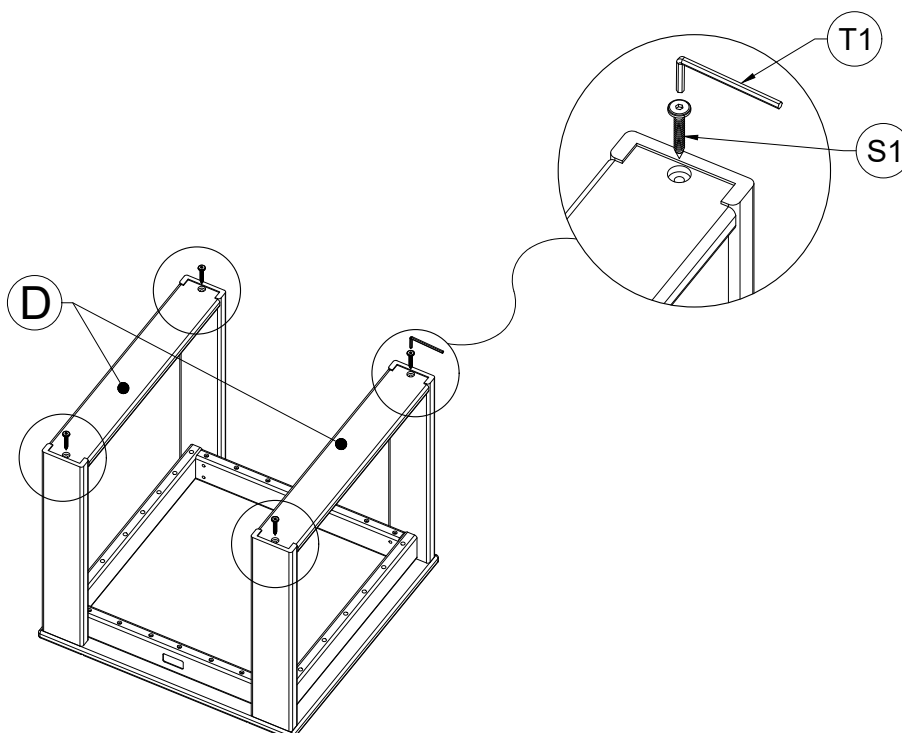

Step 3

Turn Over

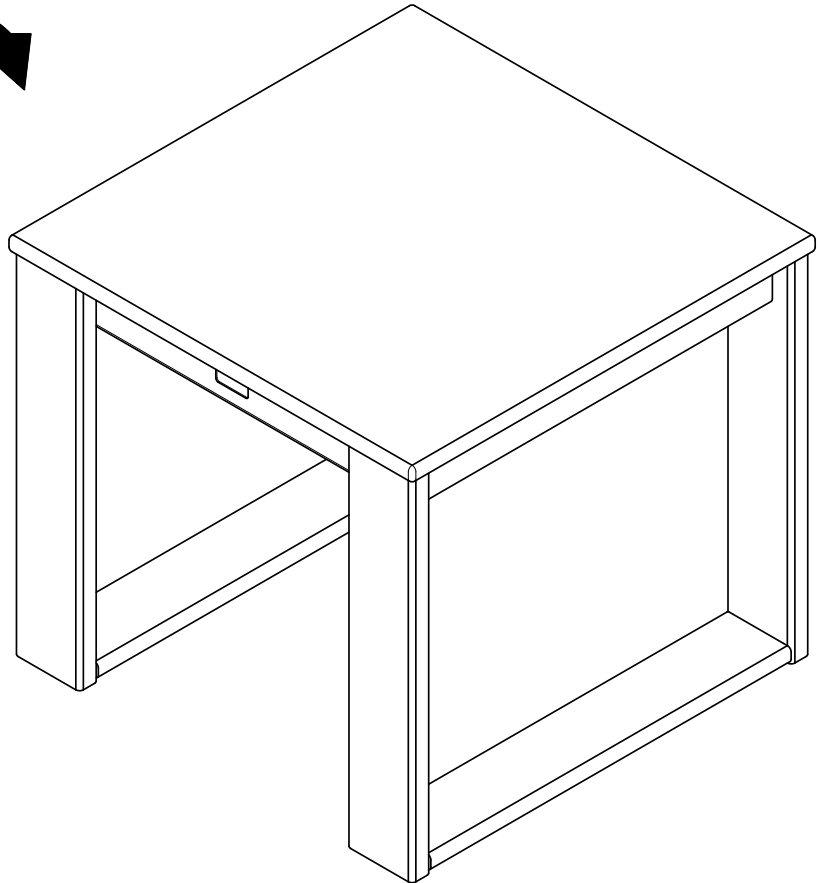

Thank You

For Your Purchase

We want you to be completely satisfied