

Bench

BN02-15

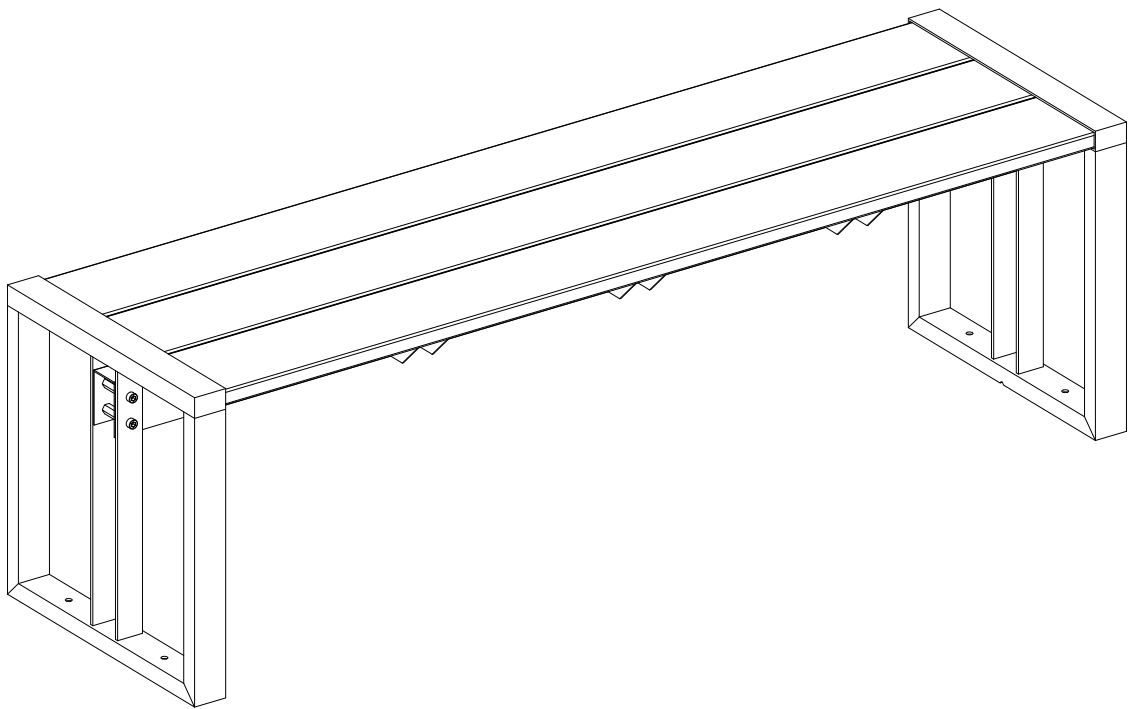

Assembly Instructions

3.3.25 US



Important Note

Please Read All Sections Carefully Before You Start

For the most up to date information, please visit our website @ www.newtechwood.com

1. Parts

Before assembling, please check the packing parts carefully according to the sections on [page 2](#) and [page 3](#), "[Tools](#)", "[Fasteners](#)" and "[Components](#)" of this Assembly Instruction sheet. If parts are missing, please contact the retailer from which you acquired this table to get the missing parts.

2. Safety

- 2.1 It is recommended to wear appropriate safety equipment to avoid any risk of injuries but it is not limited to the following safety equipment when assembling the bench: gloves, safety shoes, safety goggles, long sleeves, and pants.
- 2.2 We recommended assembling the Bench by two people to avoid any risk of injuries. **DO NOT** attempt assembling by one person.
- 2.3 The Bench is not designed for use as a standing platform. **DO NOT** stand on the Bench as there is a risk of falling and injury.

3. Tools



Always use the proper tools for assembly.

4. Assembling Procedure



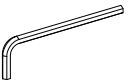

- 4.1 Please follow the steps of the Assembly Instructions sheet in order.
- 4.2 **DO NOT** tighten all the screws until all the parts are in place and assembling in alignment. Otherwise, it should cause the assembly to be misaligned. It is recommended to turn back the screws in half-turn when the head of the screws touches the parts before tightening all the screws in order.

Warranty: Please visit our website for full warranty @www.newtechwood.com

Tools

 T1 10# (Nut Driver) 1 PC	 T2 5# (Hex Key) 1 PC	 T3 6# (Hex Key) 2 PCS
---	---	--

Fasteners

 S1 M8*13/16" (Hex Socket Screw) 8 PCS	 S2 M6*13/16" (Hex Socket Screw) 6 PCS	 S3 M6 (Nylon Lock Nut) 6 PCS	 S4 M5*5/8" (Pan Head Tapping Screw) 30 PCS	 S5 M8*1-3/4" (Coupling Nut) 4 PCS
---	---	--	--	---

Components

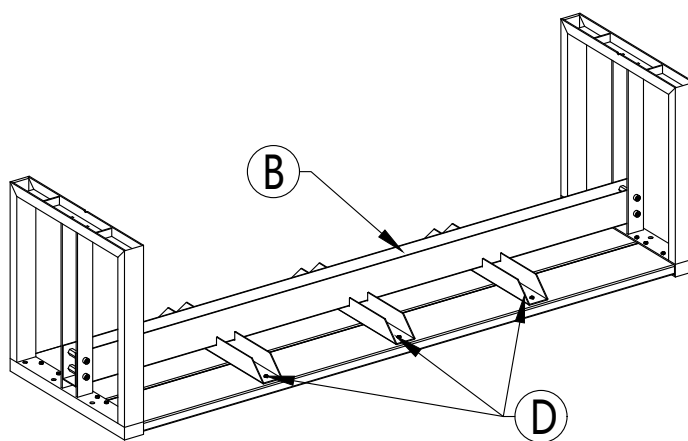
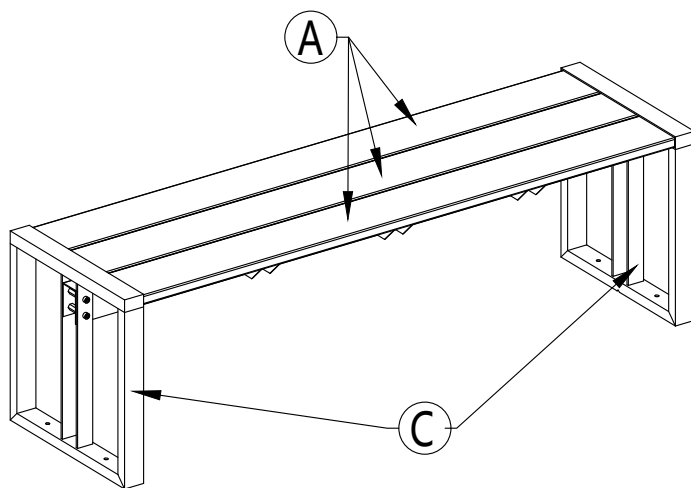

A

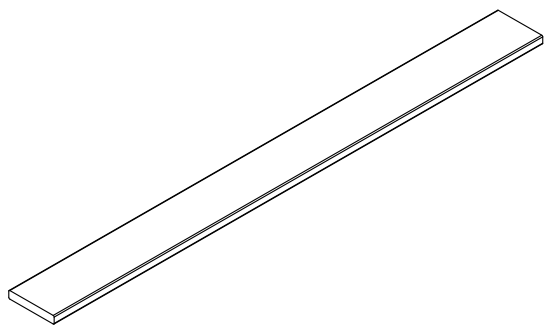

x 3

B

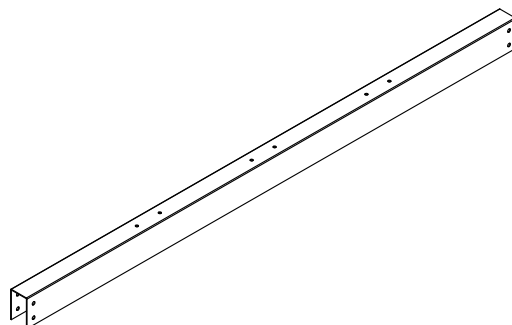

x 1

C

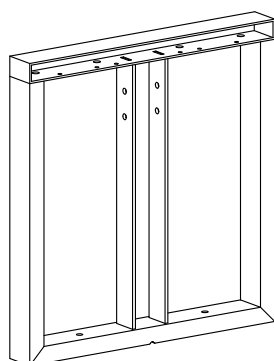

x 2

D

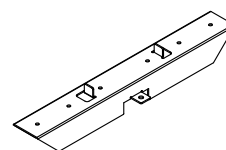

x 3

Step 1

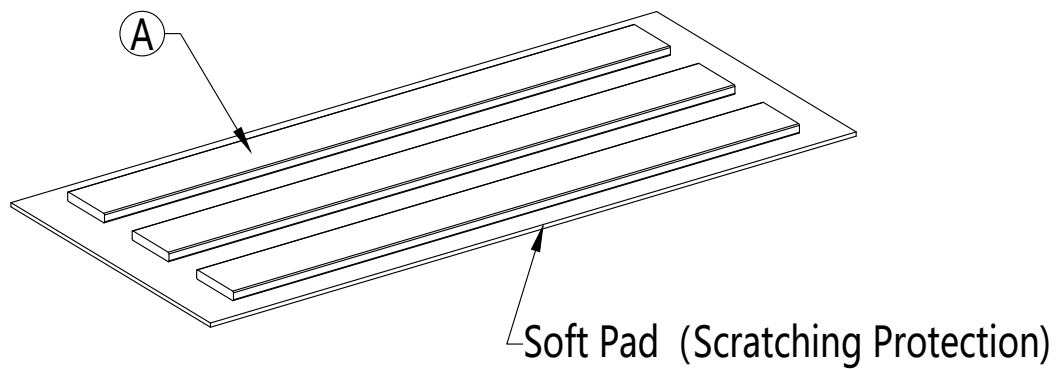

Step 2

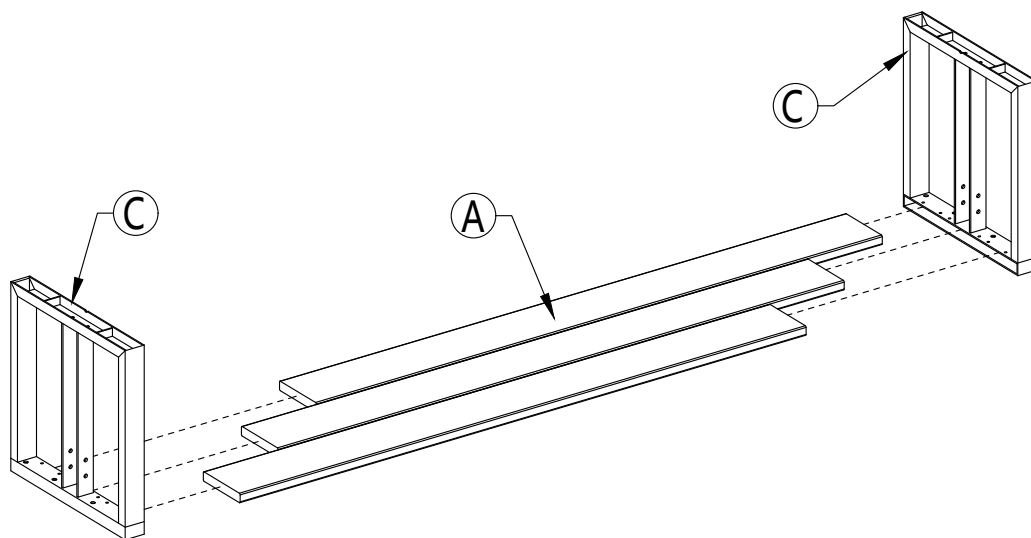

Step 3

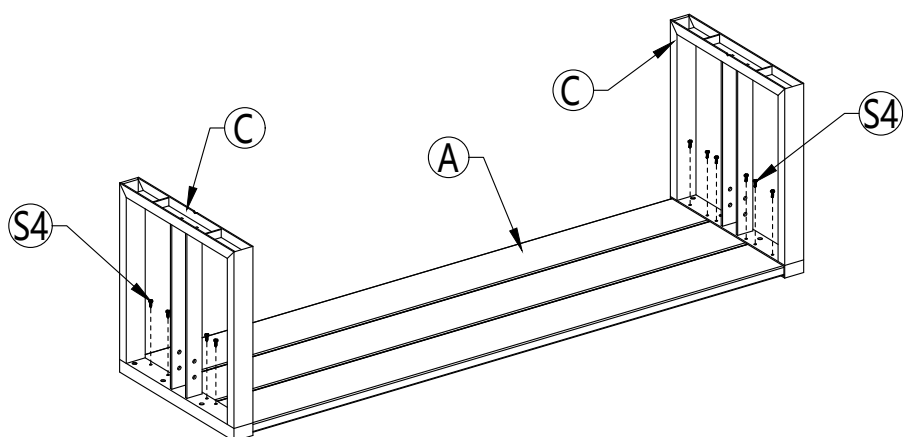

Step 4

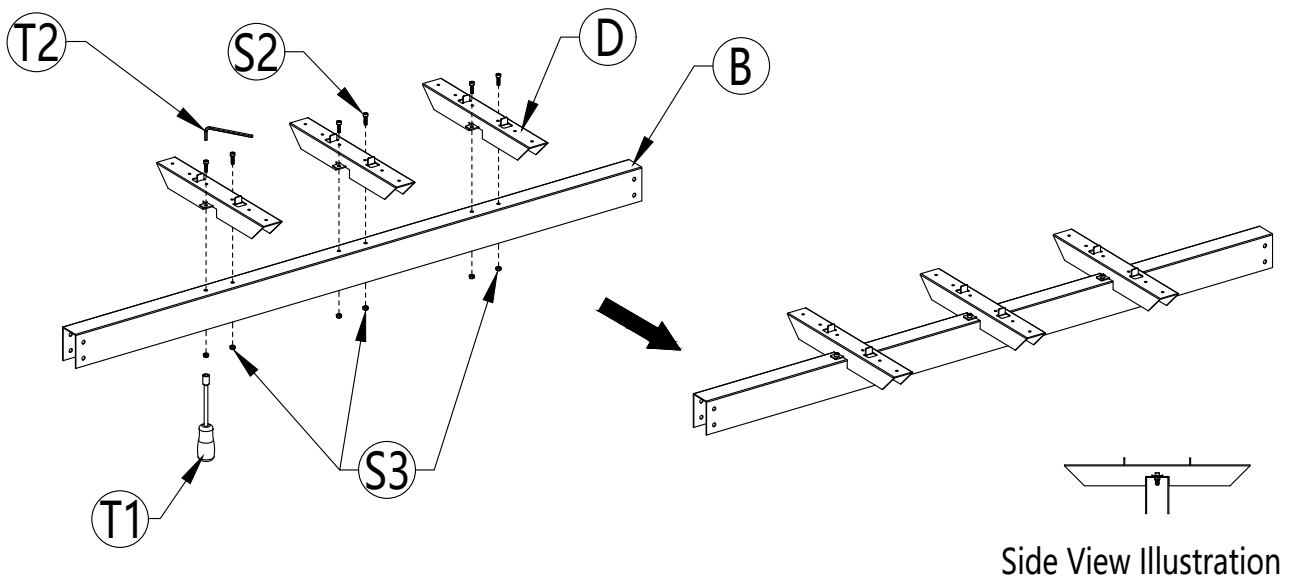

Step 5

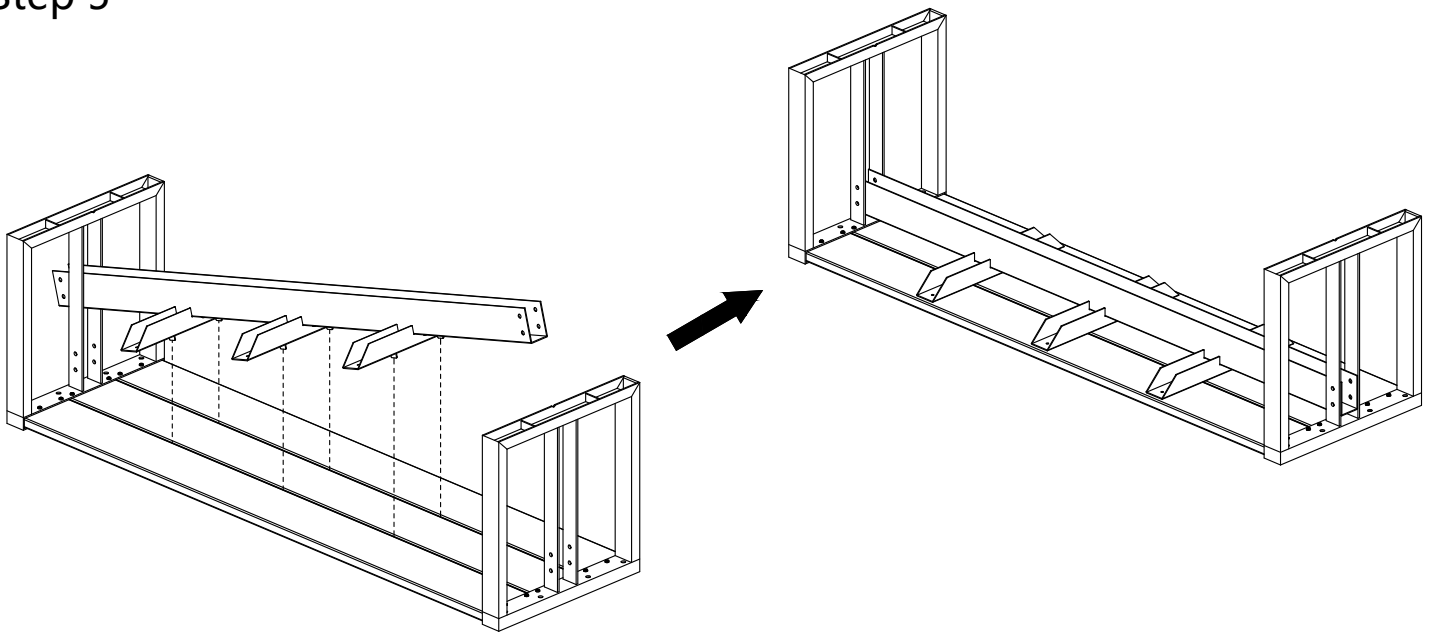

Step 6

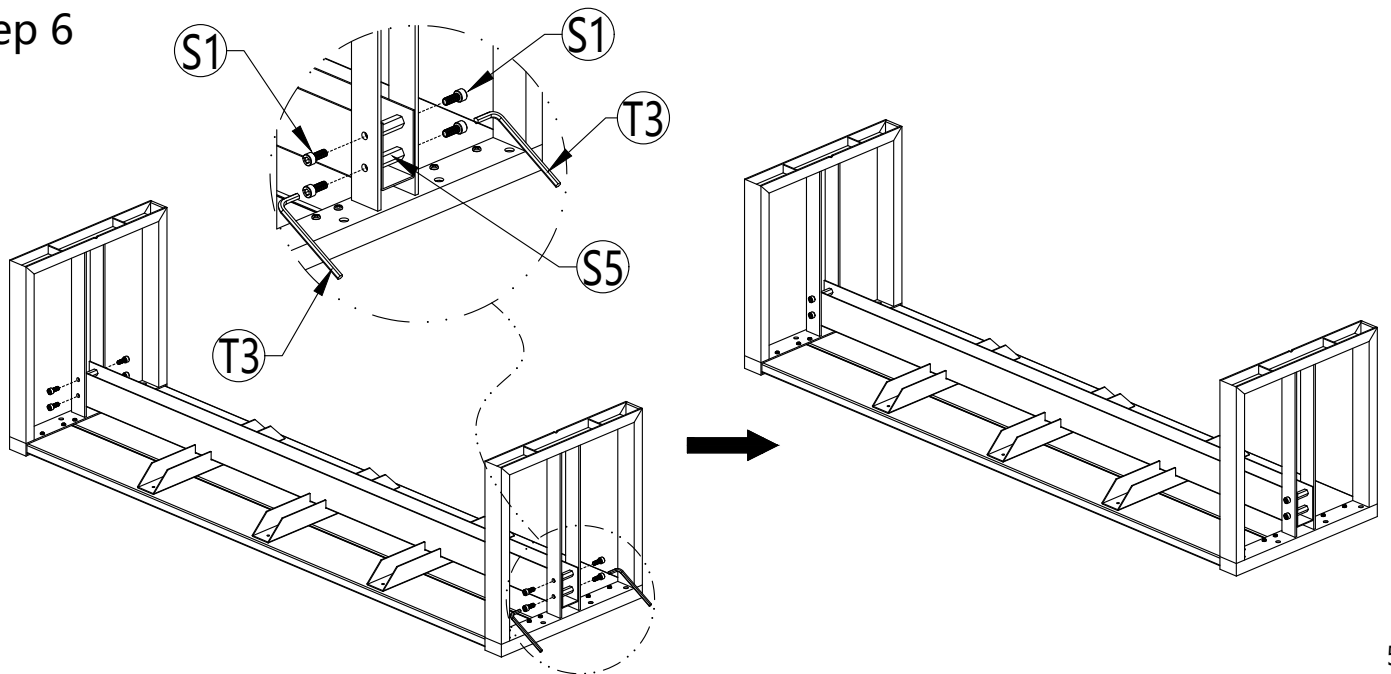

Step 7

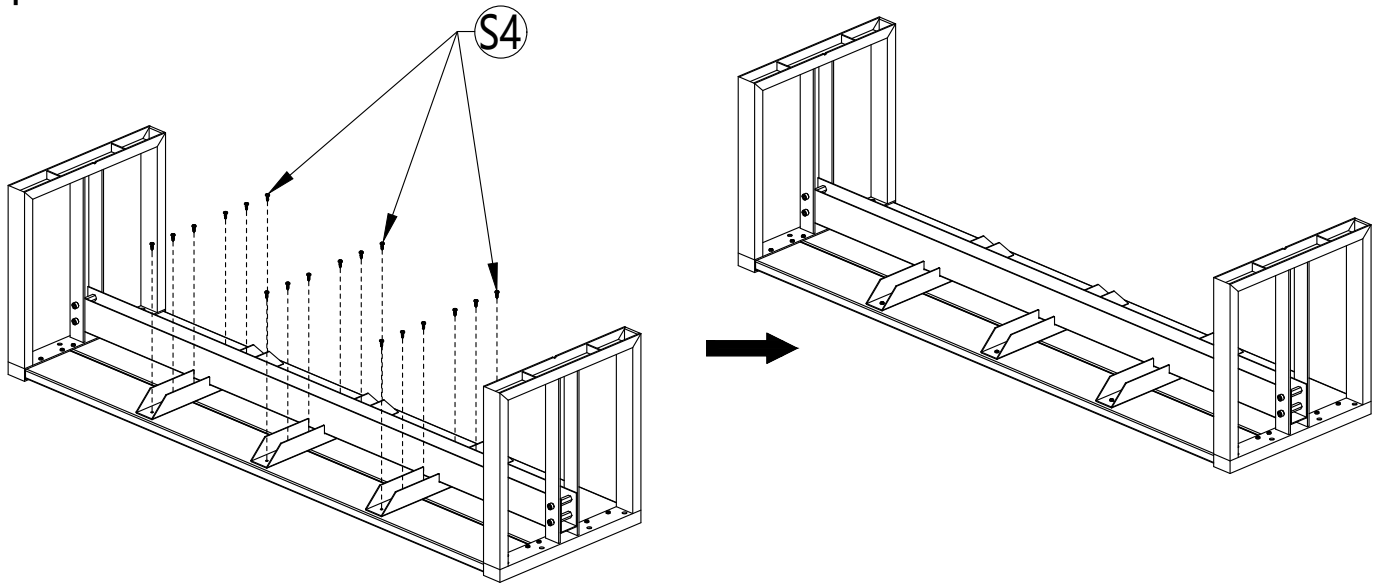

Step 8

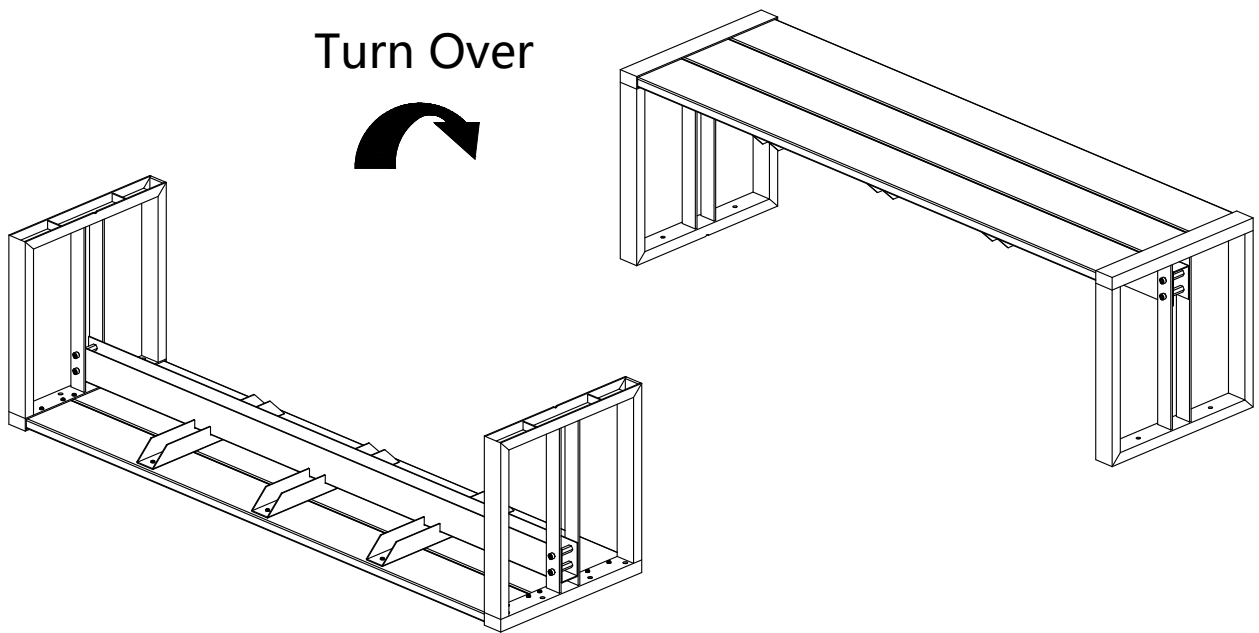

Thank You
For Your Purchase

We want you to be completely satisfied